

VOLTAGE REGULATOR WITH ON/OFF SWITCH

FEATURES

- High Precision Voltage at $\pm 1.5\%$ or ± 50 mV
- Active High On/Off Control
- Very Low Dropout Voltage: ($V_{DROPOUT} = 105$ mV at 100 mA)
- Very Good Stability: CL = 0.1 μ F is Stable for any Type Capacitor with $V_{OUT} \geq 1.8$ V ($I_{OUT} > 0.5$ mA)
- Excellent Ripple Rejection Ratio (80 dB @ 1 kHz)
- Very Low Quiescent Current ($I_Q = 65$ μ A at $I_{OUT} = 0$ mA)
- Peak Output Current is 480 mA
- SOT23L-6 Surface Mount Package
- Very Low Noise
- Built-in Reverse Bias Protection
- Internal Thermal Shutdown
- Short Circuit Protection

DESCRIPTION

The TK112xxC is a low dropout linear regulator with a built-in electronic switch. The internal switch can be controlled by TTL or CMOS logic levels. The device is in the "on" state when the control pin is pulled to a logic high level. An external capacitor can be connected to the noise bypass pin to lower the output noise level to 30 μ Vrms.

An internal PNP pass transistor is used to achieve a low dropout voltage of 170 mV (typ.) at 200 mA load current. The TK112xxC has a very low quiescent current of 65 μ A at no load and 1.8 mA with a 100 mA load. The internal thermal shut down circuitry limits the junction temperature to 150 $^{\circ}$ C. The load current is internally monitored and the device will shut down in the presence of a short circuit or overcurrent condition at the output.

APPLICATIONS

- Battery Powered Systems
- Cellular Telephones
- Pagers
- Personal Communications Equipment
- Portable Instrumentation
- Portable Consumer Equipment
- Radio Control Systems
- Toys
- Low Voltage Systems

The TK112xxCM circuit features very high stability in both DC and AC. An output capacitor of 0.1 μ F provides stable operation for $V_{OUT} \geq 2.5$ V. Any type of capacitor can be used; however, the larger this capacitor is, the better the overall characteristics are. The ripple rejection ratio is 84 dB at 400 Hz, and 80 dB at 1 kHz.

The TK112xxC is available in the SOT23L-6 surface mount package.

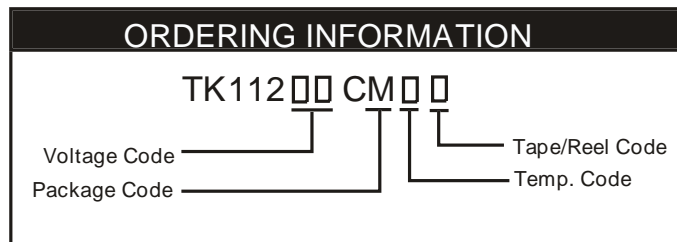

VOLTAGE CODE: Refer to Table 1	PACKAGE CODE: M: SOT23L-6	TAPE/REEL CODE: L: Tape Left Reel Size = 1300 pcs.
TEMP. CODE: C: -30 to +80 $^{\circ}$ C I: -40 to +85 $^{\circ}$ C		

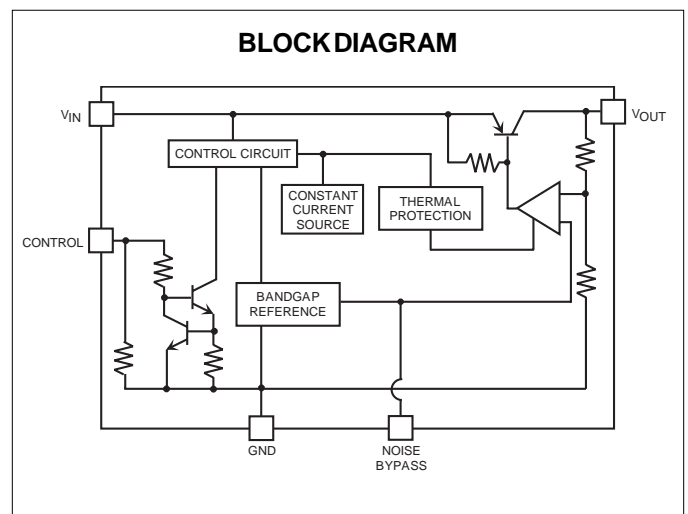
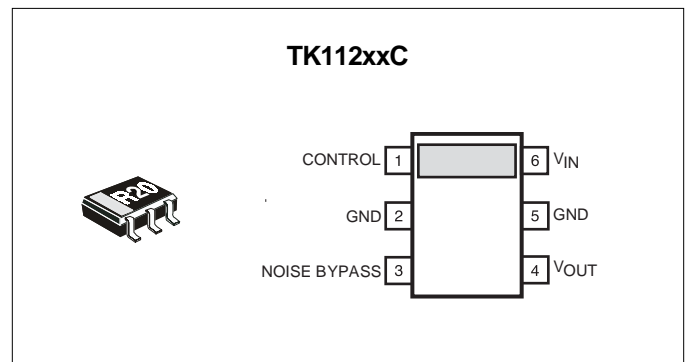

TK112xxCM

ABSOLUTE MAXIMUM RATINGS TK112xxCM - C RANK

Supply Voltage	16 V	Operating Temperature Range	-30 to +80 °C
Power Dissipation SOT-23L (Note1)	600 mW	Operating Voltage Range	1.8 to 14.5 V
Reverse Bias	6 V	Junction Temperature	150 °C
Storage Temperature Range	-55 to +150 °C		

TK112xxCM ELECTRICAL CHARACTERISTICS - C RANK

Test conditions: $T_A = 25\text{ °C}$, $V_{IN} = V_{OUT(TYP)} + 1\text{ V}$, $V_{CONT} = 1.8\text{ V}$, unless otherwise specified.

SYMBOL	PARAMETER	TEST CONDITIONS	MIN	TYP	MAX	UNITS
V_{OUT}	Output Voltage	$I_{OUT} = 5\text{ mA}$ (See table 1)	$\pm 1.5\%$ or $\pm 50\text{ mV}$			
Line Reg	Line Regulation	$\Delta V = 5\text{ V}$ ($V_{IN} = V_{OUT(TYP)} + 1\text{ V}$ to $V_{OUT(TYP)} + 6\text{ V}$)		0	6	mV
Load Reg	Load Regulation $2.5\text{ V} \leq V_{OUT} \leq 5.0\text{ V}$	$I_{OUT} = 5\text{ mA}$ to 100 mA		0.5	1.1	%
		$I_{OUT} = 5\text{ mA}$ to 200 mA		1.0	2.2	%
		$I_{OUT} = 5\text{ mA}$ to 300 mA		1.6	3.7	%
Load Reg	Load Regulation $1.5\text{ V} \leq V_{OUT} \leq 2.4\text{ V}$	$I_{OUT} = 5\text{ mA}$ to 100 mA		0.8	1.8	%
		$I_{OUT} = 5\text{ mA}$ to 200 mA		1.5	3.4	%
		$I_{OUT} = 5\text{ mA}$ to 300 mA		2.4	5.3	%
V_{DROP}	Dropout Voltage (Note 2)	$I_{OUT} = 100\text{ mA}$		105	170	mV
		$I_{OUT} = 200\text{ mA}$		170	270	mV
		$I_{OUT} = 300\text{ mA}$ ($V_{OUT} \geq 2.4\text{ V}$)		235	370	mV
$I_{OUT\ MAX}$	Maximum Output Current	$V_{OUT} = V_{OUT(TYP)} \times 0.9$	380	480		mA
I_Q	Quiescent Current	$I_{OUT} = 0\text{ mA}$ Excluding I_{CONT}		65	90	μA
I_{STBY}	Standby Current	$V_{CC} = 8\text{ V}$, $V_{CONT} \leq 0.15\text{ V}$ OFF State		0	0.1	μA
I_{GND}	Ground Pin Current	$I_{OUT} = 100\text{ mA}$		1.8	3.0	mA
CONTROL TERMINAL SPECIFICATION (Note 3)						
I_{CONT}	Control Current	$V_{CONT} = 1.8\text{ V}$, ON State		5	10	μA
V_{CONT}	Control Voltage	ON State	1.6			V
		OFF State			0.6	V

TK112xxCM ELECTRICAL CHARACTERISTICS - C RANK (CONT)

Test conditions: $T_A = 25\text{ }^\circ\text{C}$, $V_{IN} = V_{OUT(TYP)} + 1\text{ V}$, $V_{CONT} = 1.8\text{ V}$, unless otherwise specified.

SYMBOL	PARAMETER	TEST CONDITIONS	MIN	TYP	MAX	UNITS
V_{REF}	Noise Bypass Terminal Voltage			1.28		V
$\Delta V_{OUT}/\Delta T_A$	Temperature Coefficient			35		ppm / $^\circ\text{C}$
V_{NO}	Output Noise	$V_{OUT} = 3\text{ V}$, $f = 1\text{ kHz}$, $C_N = 0.1\text{ }\mu\text{F}$		0.20		$\mu\text{V} / \sqrt{\text{Hz}}$
		$V_{OUT} = 3\text{ V}$, at BW 400 Hz to 80 kHz		45		μV_{RMS}
RR	Ripple Rejection	$f = 400\text{ Hz}$, $CL = 1.0\text{ }\mu\text{F}$, $C_N = 0.01\text{ }\mu\text{F}$, $V_{NOISE} = 200\text{ mV}_{RMS}$, $V_{IN} = V_{OUT(TYP)} + 1.5\text{ V}$, $I_{OUT} = 10\text{ mA}$		84		dB
		$f = 1\text{ kHz}$, $CL = 1.0\text{ }\mu\text{F}$, $C_N = 0.01\text{ }\mu\text{F}$, $V_{NOISE} = 200\text{ mV}_{RMS}$, $V_{IN} = V_{OUT(TYP)} + 1.5\text{ V}$, $I_{OUT} = 10\text{ mA}$		80		dB

Note 1: Power dissipation is 600 mW when mounted as recommended. Decrease at the rate of 4.8 mW/ $^\circ\text{C}$ for operation above 25 $^\circ\text{C}$.

Note 2: The minimum operating voltage for V_{IN} can be 1.8 V. Also, the minimum voltage required for V_{IN} is $V_{IN} = V_{DROP} + V_{OUT}$. As a result, operating at $V_{OUT} \leq 2.0\text{ V}$ at the minimum input operating voltage is not preferred.

Note 3: The input current decreases to the pA level by connecting the control terminal to GND. (Off State). The internal Pull-down resistor is 500 k Ω .

General Note: Parameters with only typical values are just reference. (Not guaranteed)

General Note: Limits are guaranteed by production testing or correction techniques using Statistical Quality Control (SQC) methods. Unless otherwise noted. $V_{IN} = V_{OUT(TYP)} + 1\text{ V}$; $I_{OUT} = 1\text{ mA}$ ($T_J = 25\text{ }^\circ\text{C}$) The operation of -30 $^\circ\text{C}$ to 80 $^\circ\text{C}$ is guaranteed in the design by a usual inspection.

General Note: Exceeding the "Absolute Maximum Rating" may damage the device.

General Note: Connecting a capacitor to the noise bypass pin can decrease the output noise voltage.

TK112xxCM

ABSOLUTE MAXIMUM RATINGS TK112xxCM - I RANK

Supply Voltage	16 V	Operating Temperature Range	-40 to +85 °C
Power Dissipation SOT-23L (Note1)	600 mW	Operating Voltage Range	2.1 to 14.5 V
Reverse Bias	6 V	Junction Temperature	150 °C
Storage Temperature Range	-55 to +150 °C		

TK112xxCM ELECTRICAL CHARACTERISTICS - I RANK

Test conditions: $T_A = 25\text{ °C}$, $V_{IN} = V_{OUT(TYP)} + 1\text{ V}$, $I_{OUT} = 5\text{ mA}$, unless otherwise specified. Boldface type applies over the full operating temperature range. (-40~85°C).

SYMBOL	PARAMETER	TEST CONDITIONS	MIN	TYP	MAX	UNITS
V_{OUT}	Output Voltage	$I_{OUT} = 5\text{ mA}$ (See Table 1)	$\pm 1.5\%$ or $\pm 50\text{ mV}$ ($\pm 2.5\%$ or $\pm 80\text{ mV}$)			
Line Reg	Line Regulation	$\Delta V = 5\text{ V}$, ($V_{IN} = V_{OUT(TYP)} + 1\text{ V}$ to $V_{OUT(TYP)} + 6\text{ V}$)		0	6 8	mV
Load Reg	Load Regulation $2.5\text{ V} \leq V_{OUT} \leq 5.0\text{ V}$	$I_{OUT} = 5\text{ mA}$ to 100 mA		0.5	1.1 1.3	%
		$I_{OUT} = 5\text{ mA}$ to 200 mA		1.0	2.2 2.8	%
		$I_{OUT} = 5\text{ mA}$ to 300 mA		1.6	3.7 5.3	%
Load Reg	Load Regulation $1.5\text{ V} \leq V_{OUT} \leq 2.4\text{ V}$	$I_{OUT} = 5\text{ mA}$ to 100 mA		0.8	1.8 2.0	%
		$I_{OUT} = 5\text{ mA}$ to 200 mA		1.5	3.4 4.1	%
		$I_{OUT} = 5\text{ mA}$ to 300 mA		2.4	5.3 6.5	%
V_{DROP}	Dropout Voltage (Note 2)	$I_{OUT} = 100\text{ mA}$		105	170 200	mV
		$I_{OUT} = 200\text{ mA}$		170	270 320	mV
		$I_{OUT} = 300\text{ mA}$ ($V_{OUT} \geq 2.4\text{ V}$)		235	370 440	mV
$I_{OUT\text{ MAX}}$	Maximum Output Current	$V_{OUT} = V_{OUT(TYP)} \times 0.9$	380 340	480		Ma
I_Q	Quiescent Current	$I_{OUT} = 0\text{ mA}$ Excluding I_{CONT}		65	90 100	μA
I_{STBY}	Standby Current	$V_{CONT} \leq 0.15\text{ V}$ OFF State		0	0.1 0.5	μA
I_{GND}	Ground Pin Current	$I_{OUT} = 100\text{ mA}$		1.8	3.0 3.6	mA

TK112xxCM ELECTRICAL CHARACTERISTICS - I RANK (CONT)

Test conditions: $T_A = 25\text{ }^\circ\text{C}$, $V_{IN} = V_{OUT(TYP)} + 1\text{V}$, $I_{OUT} = 5\text{ mA}$, unless otherwise specified. Boldface type applies over the full operating temperature range. (-40~85°C).

SYMBOL	PARAMETER	TEST CONDITIONS	MIN	TYP	MAX	UNITS
CONTROL TERMINAL SPECIFICATION (Note 3)						
I_{CONT}	Control Current	$V_{CONT} = 1.8\text{ V}$, ON State		5	10 12	mA
V_{CONT}	Control Voltage	ON State	1.6 1.8			V
		OFF State			0.6 0.35	V
V_{REF}	Noise Bypass Terminal Voltage			1.28		V
$\Delta V_{OUT}/\Delta T_A$	Temperature Coefficient			35		ppm / °C
V_{NO}	Output Noise	$V_{OUT} = 3\text{ V}$, $f = 1\text{ kHz}$, $C_N = 0.1\text{ }\mu\text{F}$		0.20		$\mu\text{V} / \sqrt{\text{Hz}}$
		$V_{OUT} = 3\text{ V}$, at BW 400 Hz to 80 kHz		45		μV_{RMS}
RR	Ripple Rejection	$f = 400\text{ Hz}$, $CL = 1.0\text{ }\mu\text{F}$, $C_N = 0.01\text{ }\mu\text{F}$, $V_{NOISE} = 200\text{ mV}_{RMS}$, $V_{IN} = V_{OUT(TYP)} + 1.5\text{ V}$, $I_{OUT} = 10\text{ mA}$		84		dB
		$f = 1\text{ kHz}$, $CL = 1.0\text{ }\mu\text{F}$, $C_N = 0.01\text{ }\mu\text{F}$, $V_{NOISE} = 200\text{ mV}_{RMS}$, $V_{IN} = V_{OUT(TYP)} + 1.5\text{ V}$, $I_{OUT} = 10\text{ mA}$		80		dB

Note 1: Power dissipation is 600 mW when mounted as recommended. Decrease at the rate of 4.8 mW/°C for operation above 25 °C.

Note 2: The minimum operating voltage for V_{IN} can be 1.8 V. Also, the minimum voltage required for V_{IN} is $V_{IN} = V_{DROP} + V_{OUT}$. As a result, operating at $V_{OUT} \leq 2.0\text{ V}$ at the minimum input operating voltage is not preferred.

Note 3: The input current decreases to the pA level by connecting the control terminal to GND. (Off State). The internal Pull-down resistor is 500 kΩ.

General Note: Parameters with only typical values are just reference. (Not guaranteed)

General Note: Limits are guaranteed by production testing or correction techniques using Statistical Quality Control (SQC) methods. Unless otherwise noted. $V_{IN} = V_{OUT(TYP)} + 1\text{ V}$; $I_{OUT} = 1\text{ mA}$ ($T_j = 25\text{ }^\circ\text{C}$) The operation of -30°C to 80°C is guaranteed in the design by a usual inspection.

General Note: Exceeding the "Absolute Maximum Rating" may damage the device.

General Note: Connecting a capacitor to the noise bypass pin can decrease the output noise voltage.

TK112xxCM

TK112xxCM ELECTRICAL CHARACTERISTICS TABLE 1

Test conditions: $V_{IN} = V_{OUT(TYP)} + 1\text{ V}$, $I_{OUT} = 5\text{ mA}$, unless otherwise specified.

Availability	Output Voltage	Voltage Code	Standard Temp. Range Spec. Room Temp ($T_A = 25^\circ\text{C}$)		Extended Temp. Range. Spec. Full Temp ($T_A = -40\text{ to }85^\circ\text{C}$)	
			$V_{OUT}\text{ Min}$	$V_{OUT}\text{ Max}$	$V_{OUT}\text{ Min}$	$V_{OUT}\text{ Max}$
*	1.5 V	15	1.450 V	1.550 V	1.420 V	1.580 V
	1.6 V	16	1.550 V	1.650 V	1.520 V	1.680 V
	1.7 V	17	1.650 V	1.750 V	1.620 V	1.780 V
*	1.8 V	18	1.750 V	1.850 V	1.720 V	1.880 V
*	1.9 V	19	1.850 V	1.950 V	1.820 V	1.980 V
*	2.0 V	20	1.950 V	2.050 V	1.920 V	2.080 V
	2.1 V	21	2.050 V	2.150 V	2.020 V	2.180 V
*	2.2 V	22	2.150 V	2.250 V	2.120 V	2.280 V
	2.3 V	23	2.250 V	2.350 V	2.220 V	2.380 V
	2.4 V	24	2.350 V	2.450 V	2.320 V	2.480 V
*	2.5 V	25	2.450 V	2.550 V	2.420 V	2.580 V
	2.6 V	26	2.550 V	2.650 V	2.520 V	2.680 V
*	2.7 V	27	2.650 V	2.750 V	2.620 V	2.780 V
*	2.8 V	28	2.750 V	2.850 V	2.720 V	2.880 V
*	2.9 V	29	2.850 V	2.950 V	2.820 V	2.980 V
*	3.0 V	30	2.950 V	3.050 V	2.920 V	3.080 V
*	3.1 V	31	3.050 V	3.150 V	3.020 V	3.180 V
*	3.2 V	32	3.150 V	3.250 V	3.120 V	3.280 V
*	3.3 V	33	3.250 V	3.350 V	3.217 V	3.383 V
	3.4 V	34	3.349 V	3.451 V	3.315 V	3.485 V
*	3.5 V	35	3.447 V	3.553 V	3.412 V	3.588 V

Note: * Denotes voltage presently available.
Consult factory for availability of other voltages.

TK112xxCM ELECTRICAL CHARACTERISTICS TABLE 1 (CONT)

Test conditions: $V_{IN} = V_{OUT(TYP)} + 1 \text{ V}$, $I_{OUT} = 5 \text{ mA}$, unless otherwise specified.

Availability	Output Voltage	Voltage Code	Standard Temp. Range Spec. Room Temp ($T_A = 25^\circ\text{C}$)		Extended Temp. Range. Spec. Full Temp ($T_A = -40 \text{ to } 85^\circ\text{C}$)	
			$V_{OUT} \text{ Min}$	$V_{OUT} \text{ Max}$	$V_{OUT} \text{ Min}$	$V_{OUT} \text{ Max}$
*	3.6 V	36	3.546 V	3.654 V	3.510 V	3.690 V
	3.7 V	37	3.644 V	3.756 V	3.607 V	3.793 V
*	3.8 V	38	3.743 V	3.857 V	3.705 V	3.895 V
	3.9 V	39	3.841 V	3.959 V	3.802 V	3.998 V
*	4.0 V	40	3.940 V	4.060 V	3.900 V	4.100 V
	4.1 V	41	4.038 V	4.162 V	3.997 V	4.203 V
	4.2 V	42	4.137 V	4.263 V	4.095 V	4.305 V
	4.3 V	43	4.235 V	4.365 V	4.192 V	4.408 V
	4.4 V	44	4.334 V	4.466 V	4.290 V	4.510 V
*	4.5 V	45	4.432 V	4.568 V	4.387 V	4.613 V
	4.6 V	46	4.531 V	4.669 V	4.485 V	4.715 V
*	4.7 V	47	4.629 V	4.771 V	4.582 V	4.818 V
	4.8 V	48	4.728 V	4.872 V	4.680 V	4.920 V
	4.9 V	49	4.826 V	4.974 V	4.777 V	5.023 V
*	5.0 V	50	4.925 V	5.075 V	4.875 V	5.125 V

Note: * Denotes voltage presently available.
Consult factory for availability of other voltages.

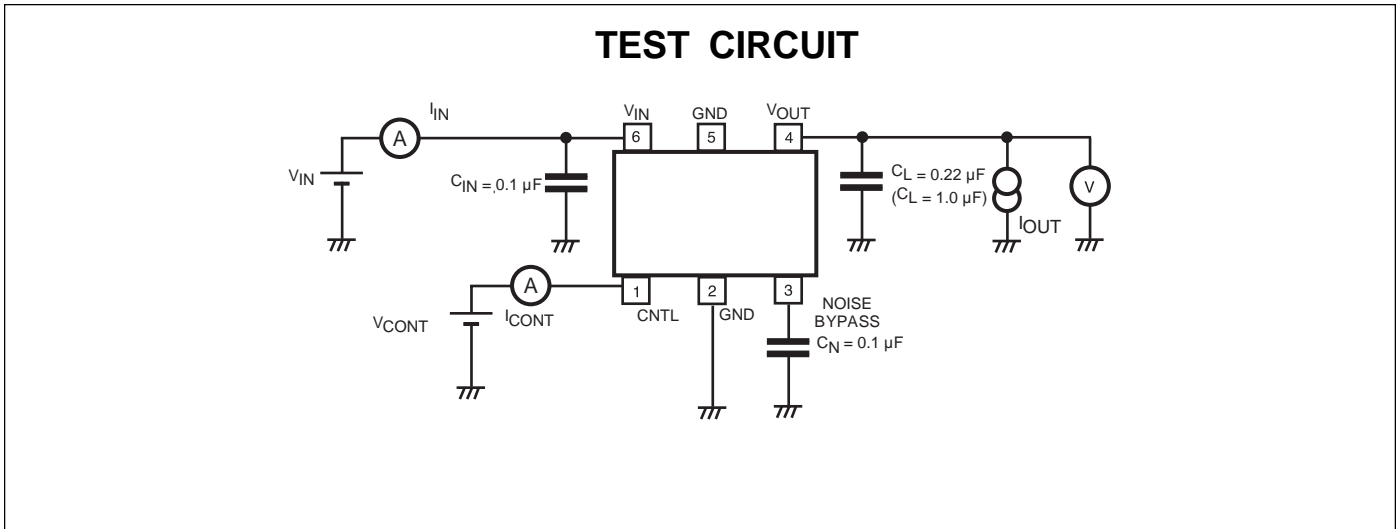

TYPICAL PERFORMANCE CHARACTERISTICS

$T_A = 25\text{ }^\circ\text{C}$, unless otherwise specified.

OUTPUT NOISE

TK11230 CN vs. NOISE $I_{OUT} = 30\text{ mA}$ BPF = 400 Hz ~ 80 kHz

TK11230C C_N vs. NOISE

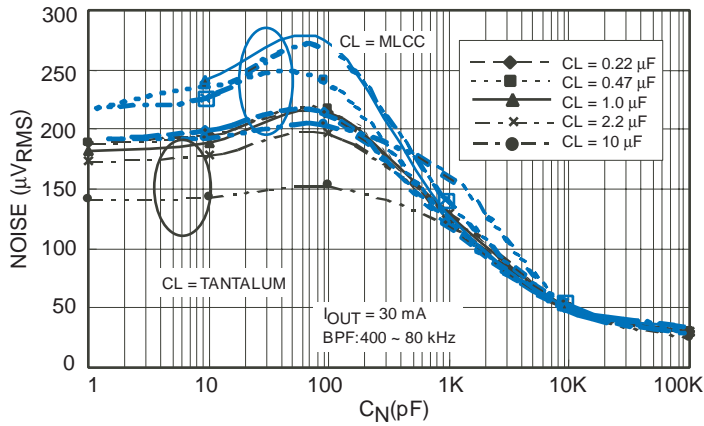

TK112xxC V_{OUT} vs. NOISE

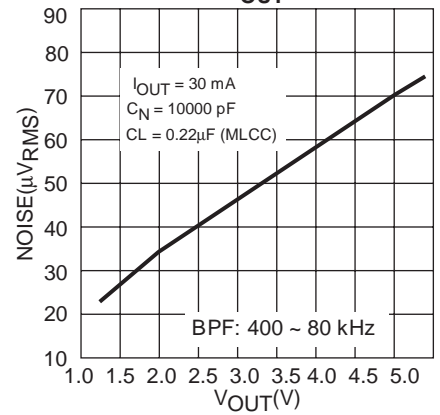

TK11230C I_{OUT} vs. NOISE

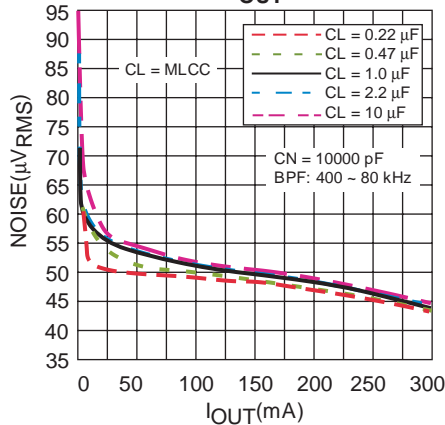

TK11230C I_{OUT} vs. NOISE

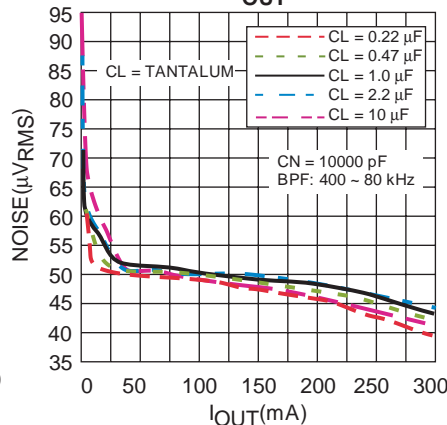

NOISE LEVEL (1/f)

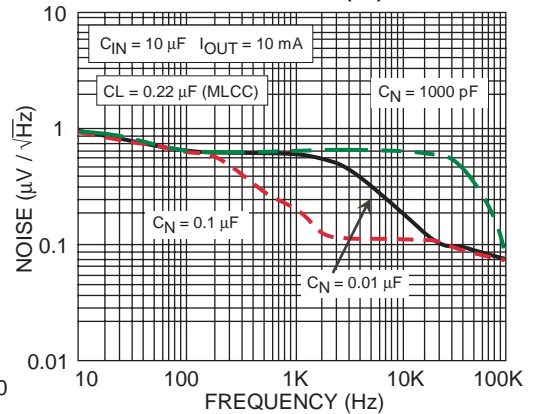

TYPICAL PERFORMANCE CHARACTERISTICS (CONT.)

$T_A = 25\text{ }^\circ\text{C}$, unless otherwise specified.

RIPPLE REJECTION

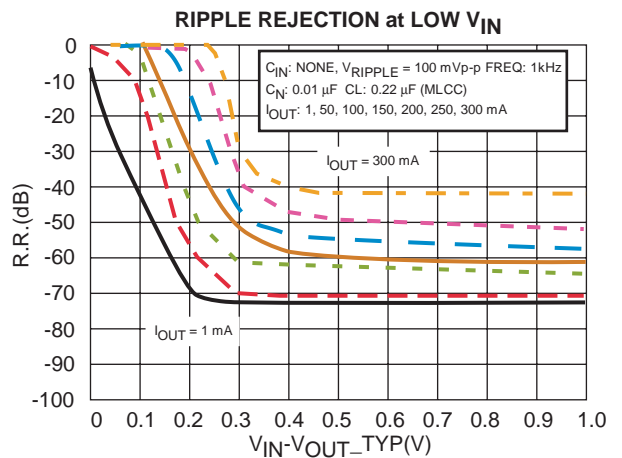
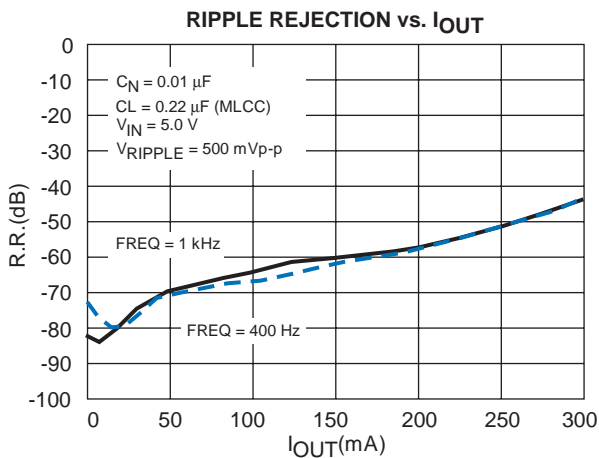
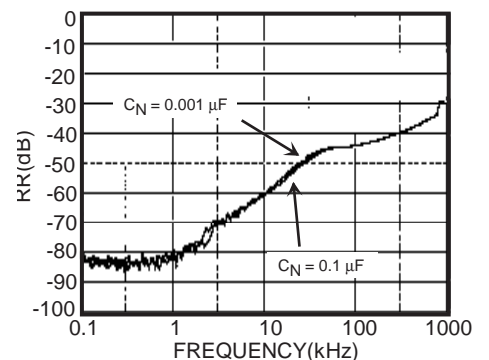
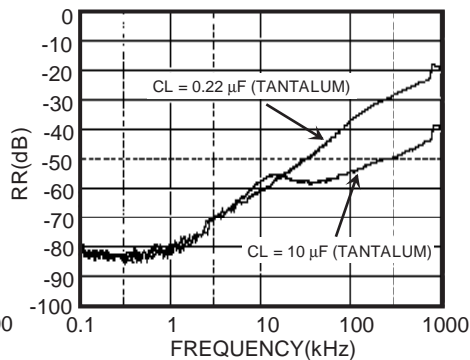
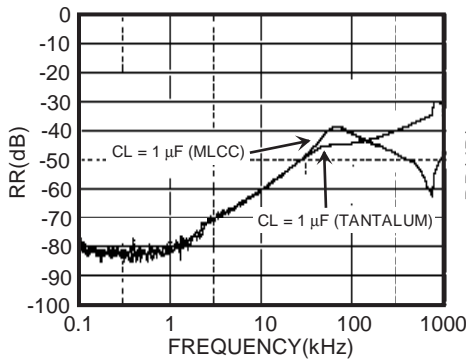
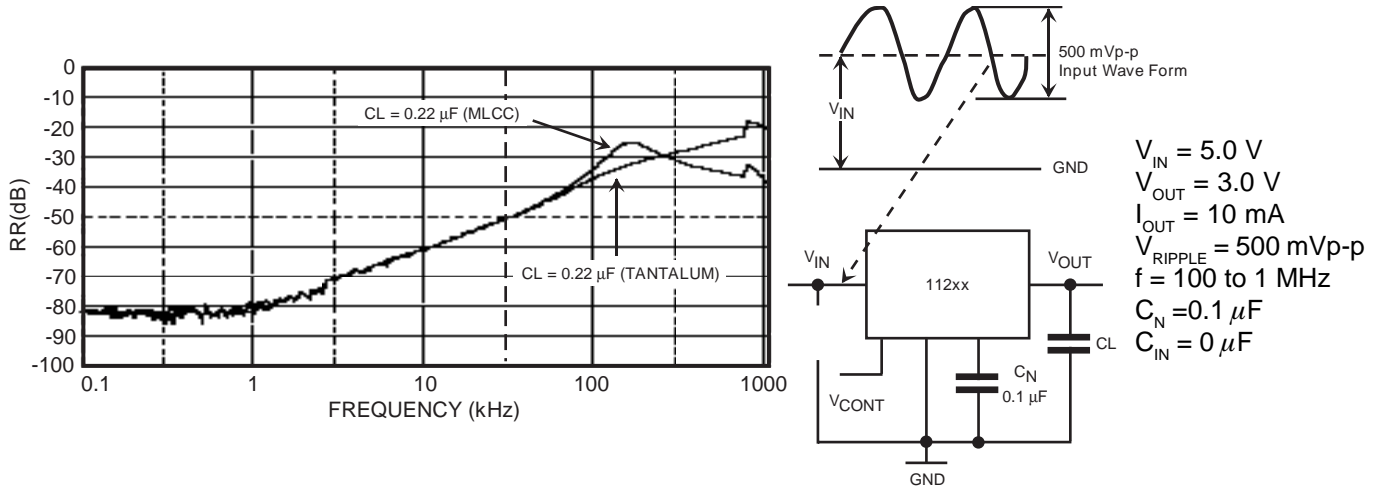

TYPICAL PERFORMANCE CHARACTERISTICS (CONT.)

$T_A = 25\text{ }^\circ\text{C}$, unless otherwise specified.

* ON / OFF TRANSIENT

TK112xxCM TRANSIENT

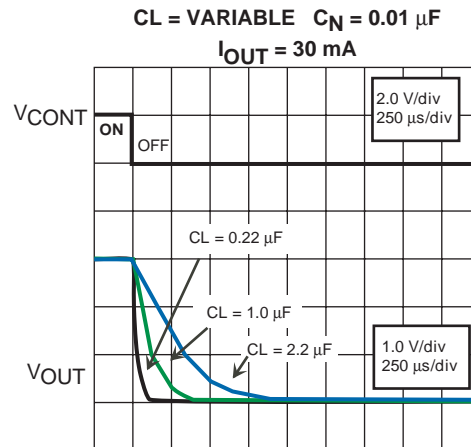
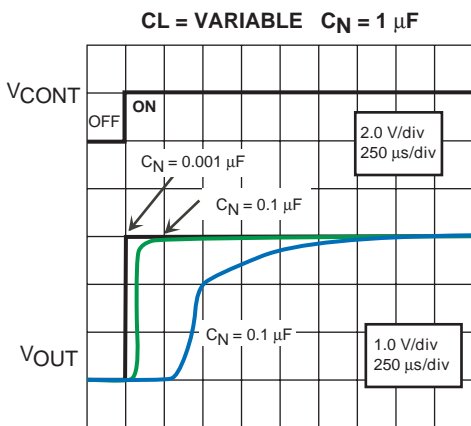
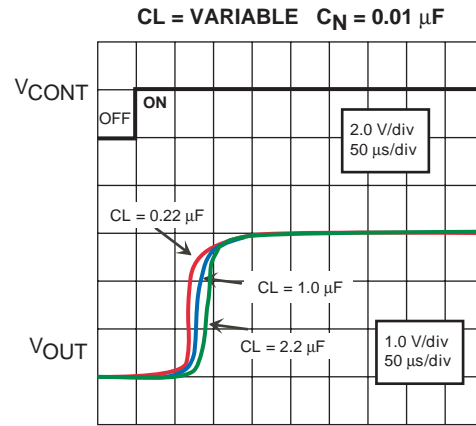
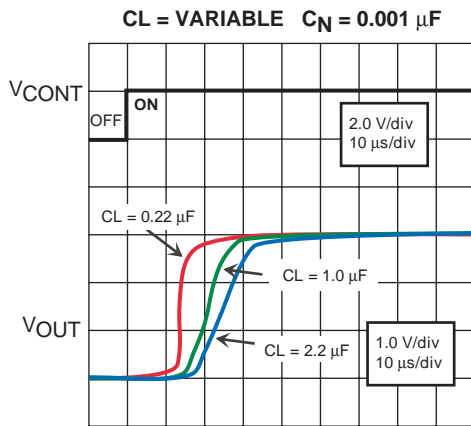
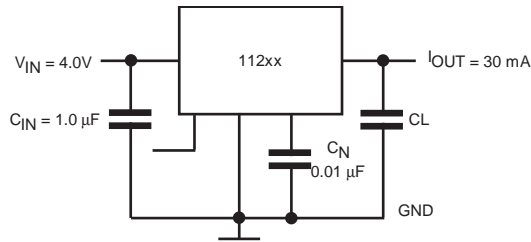

The rise time of the regulator depends on CL and C_N ; the fall time depends on CL.

TYPICAL PERFORMANCE CHARACTERISTICS (CONT.)

$T_A = 25\text{ }^\circ\text{C}$, unless otherwise specified.

*** LOAD TRANSIENT**

CL = VARIABLE CN = 0.01 μF

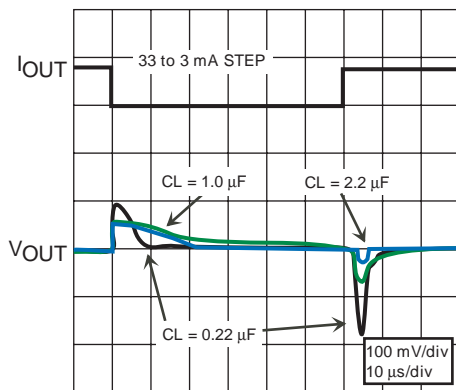

$I_{OUT} = 0$ to 30 mA,
 $I_{OUT} = 3$ to 33 mA

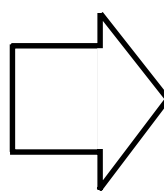
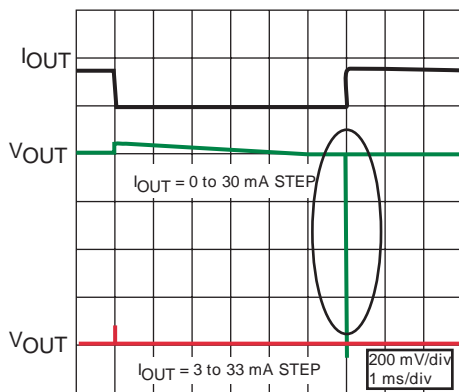

MAGNIFICATION

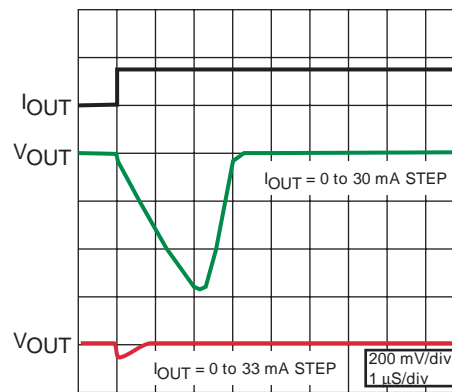

When the capacitor on the load side is increased, the load change becomes smaller.

The no load voltage change can be greatly improved by delivering a little load current to ground (see right curve above) Increase the load side capacitor when the load change is fast or when there is a large current change. In addition, at no load, the voltage change can be reduced by delivering a little load current to ground.

*** LINE TRANSIENT**

CL = VARIABLE
CN = 0.01 μF

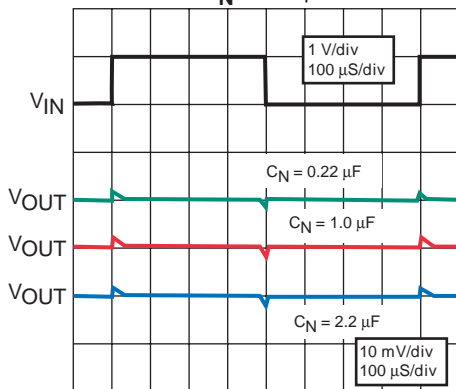

CL = VARIABLE
CN = 0.01 μF

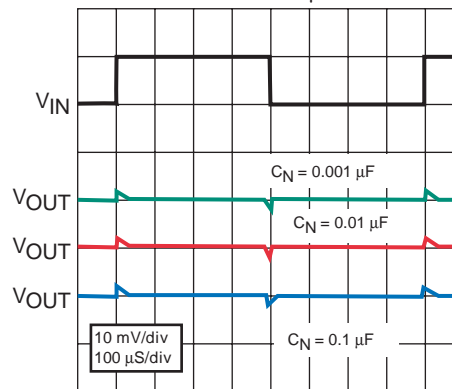

TYPICAL PERFORMANCE CHARACTERISTICS (CONT.)

$T_A = 25\text{ }^\circ\text{C}$, unless otherwise specified.

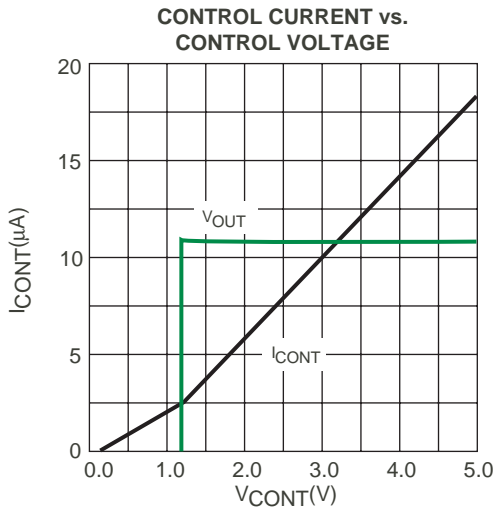
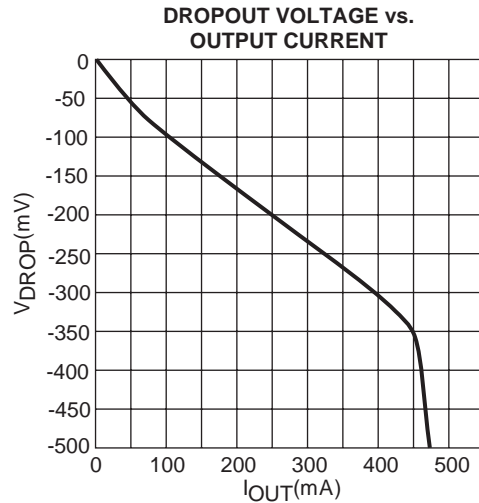
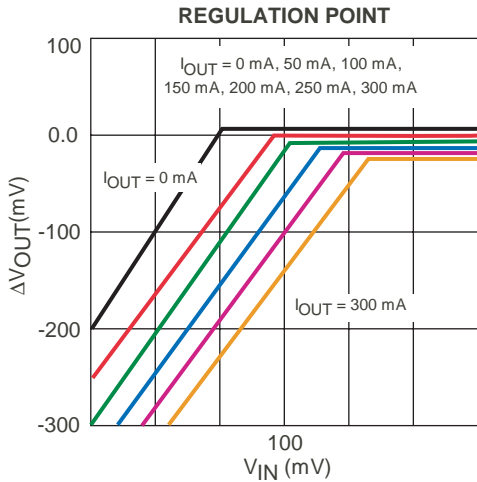
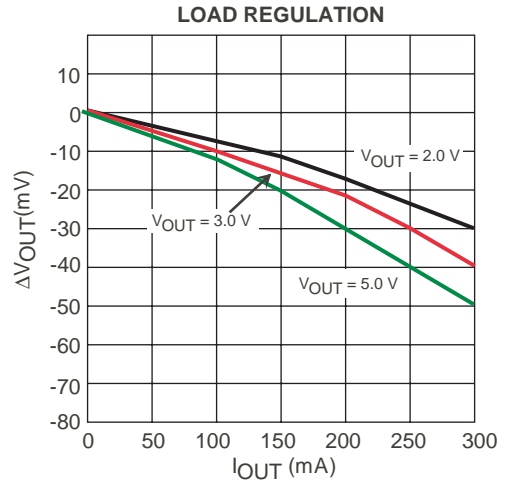
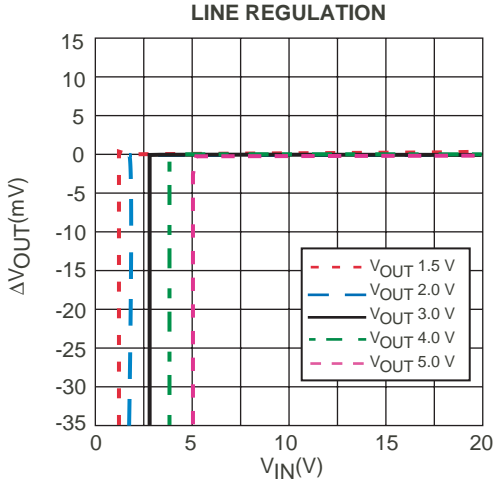

TYPICAL PERFORMANCE CHARACTERISTICS (CONT.)

$T_A = 25\text{ }^\circ\text{C}$, unless otherwise specified.

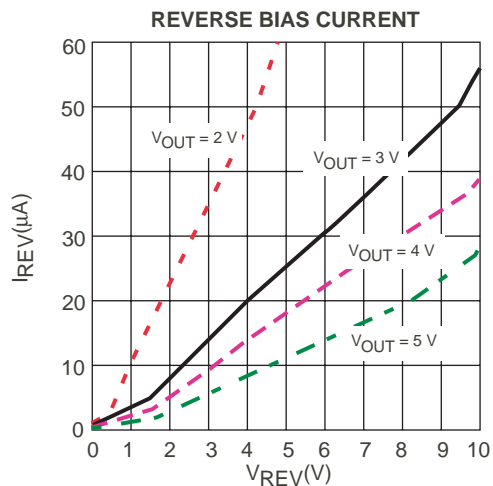
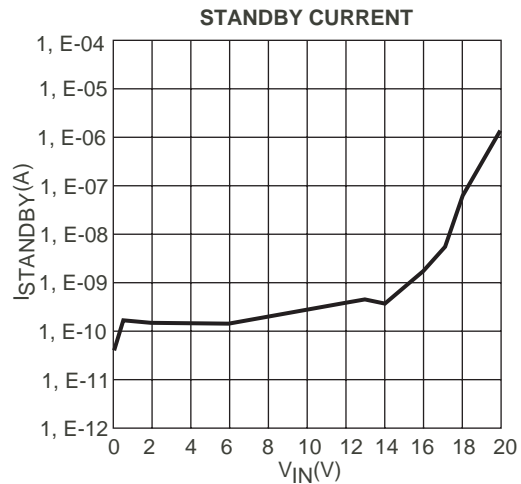
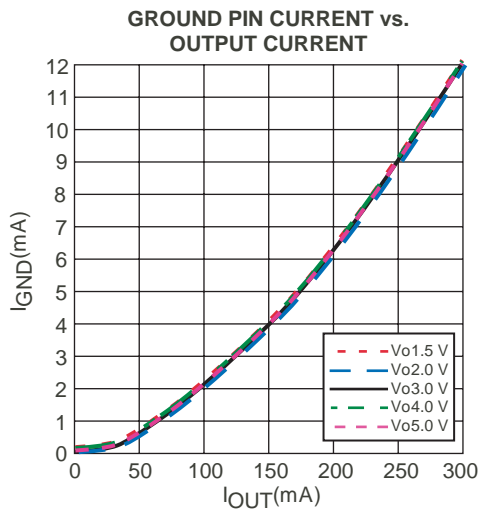
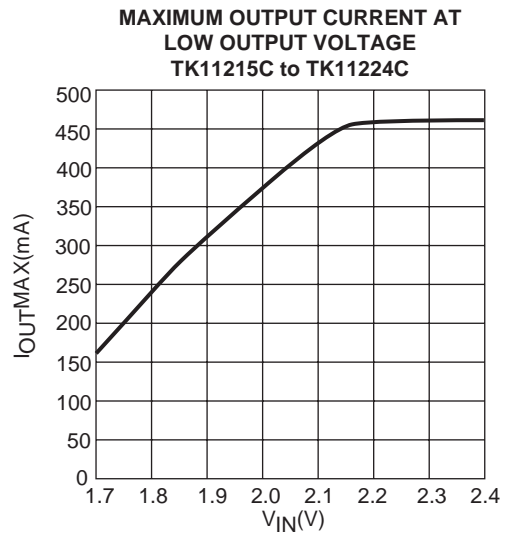
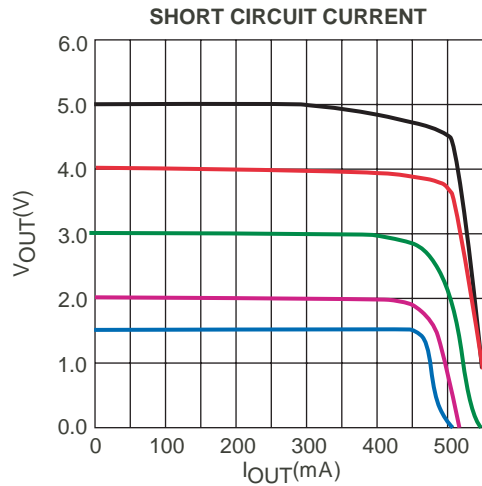

TYPICAL PERFORMANCE CHARACTERISTICS (CONT.)

$T_A = 25\text{ }^\circ\text{C}$, unless otherwise specified.

TEMPERATURE CHARACTERISTICS

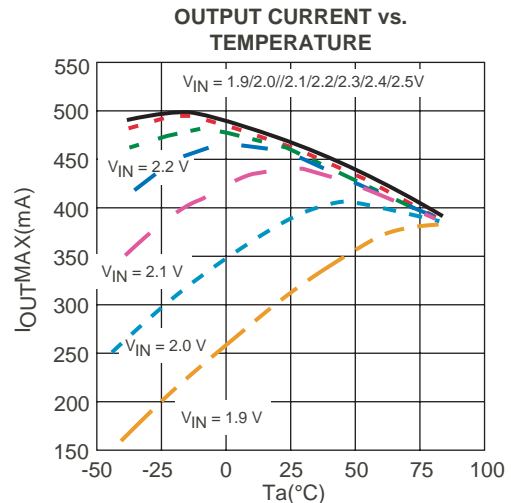
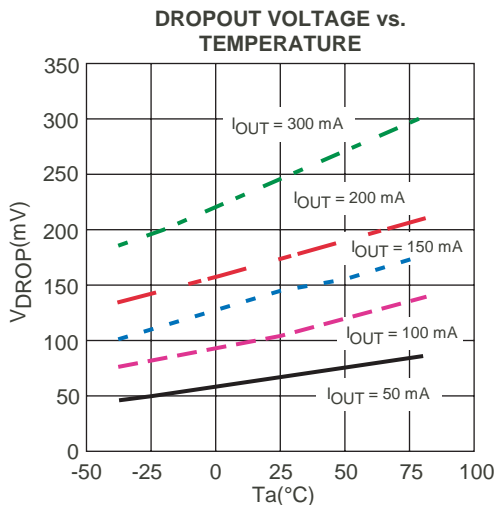
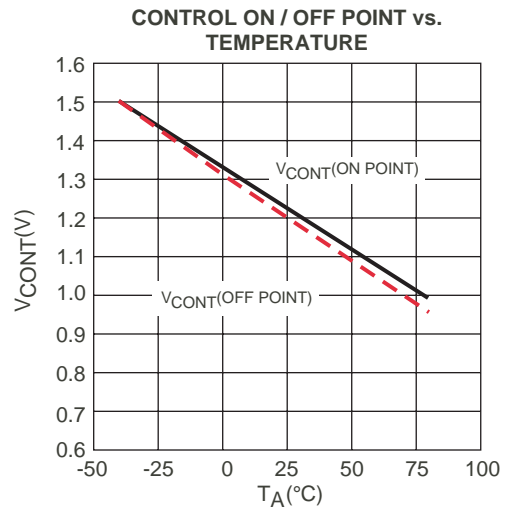
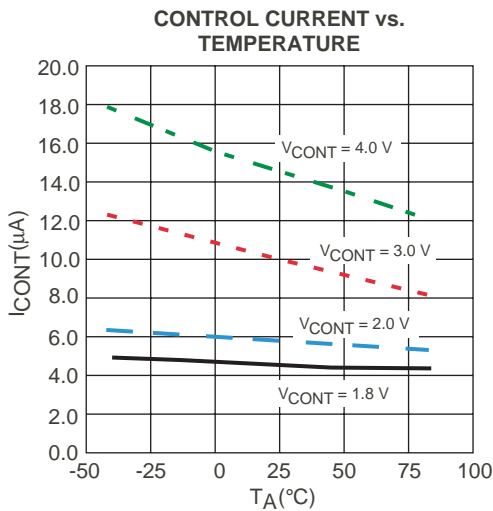
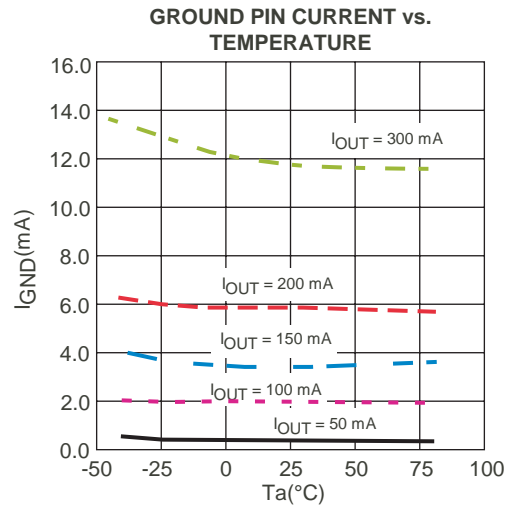
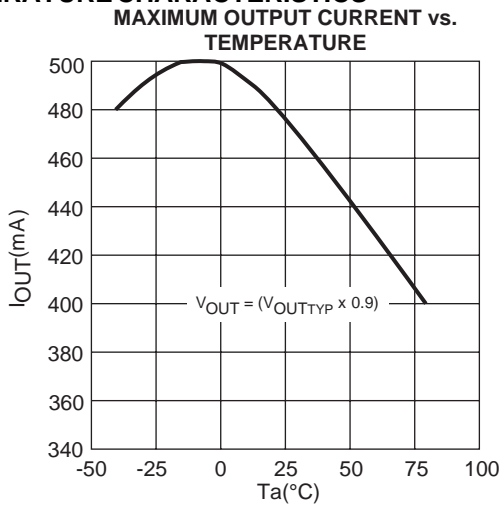

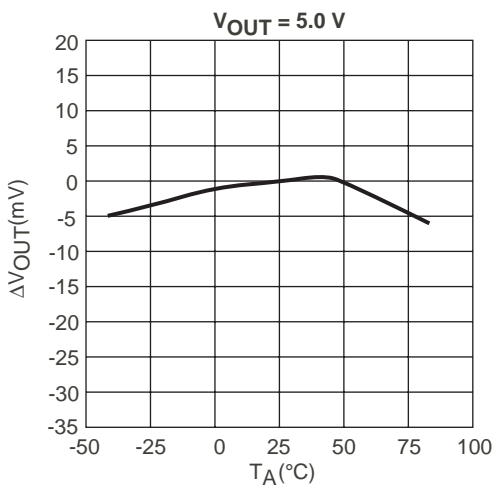
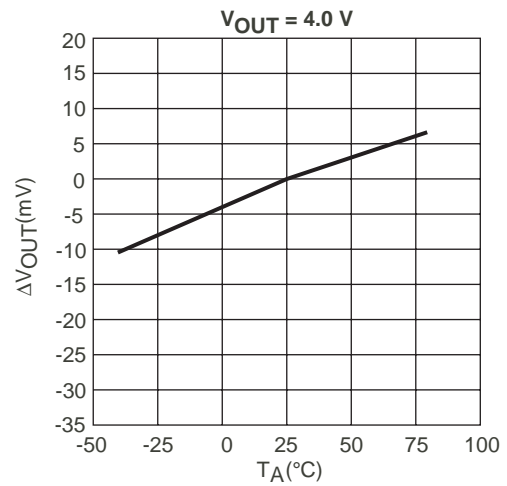
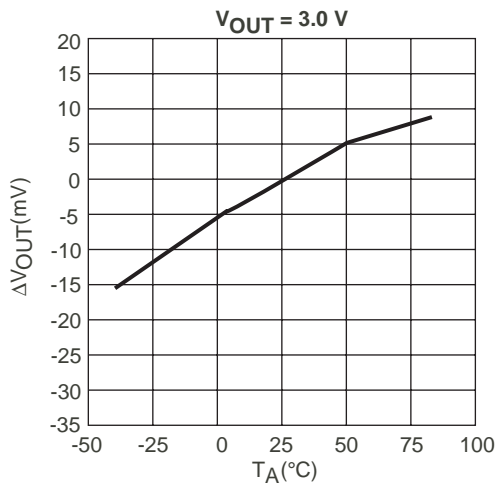
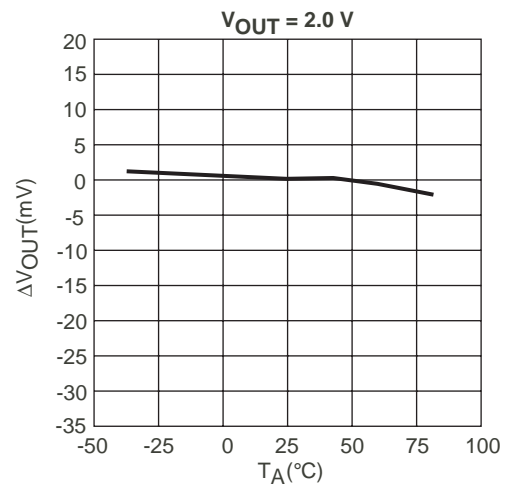
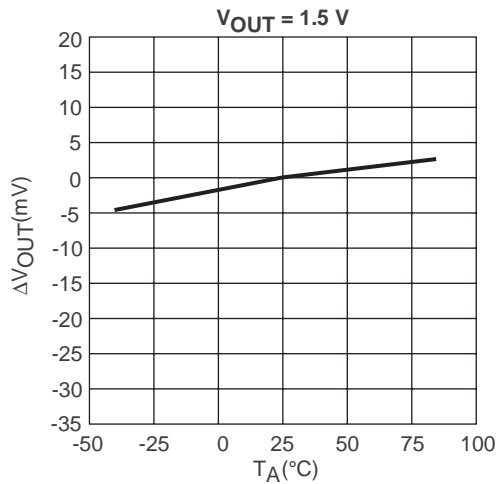
TYPICAL PERFORMANCE CHARACTERISTICS (CONT.) $T_A = 25\text{ }^\circ\text{C}$, unless otherwise specified.**OUTPUT VOLTAGE vs. TEMPERATURE CHARACTERISTICS**

DEFINITION AND EXPLANATION OF TECHNICAL TERMS

OUTPUT VOLTAGE (V_{OUT})

The output voltage is specified with $V_{IN} = V_{OUT(TYP)} + 1\text{ V}$ and $I_{OUT} = 5\text{ mA}$.

MAXIMUM OUTPUT CURRENT ($I_{OUT(MAX)}$)

The rated output current is specified under the condition where the output voltage drops 0.9 times the value specified with $I_{OUT} = 5\text{ mA}$. The input voltage is set to $V_{OUT(TYP)} + 1\text{ V}$, and the current is pulsed to minimize temperature effect. The output current decreases during low voltage operation.

DROPOUT VOLTAGE (V_{DROP})

The dropout voltage is the difference between the input voltage and the output voltage at which point the regulator starts to fall out of regulation (this is the point when the output voltage decreases by 100 mV). Below this value, the output voltage will fall as the input voltage is reduced. It is dependent upon the load current and the junction temperature.

LINE REGULATION (Line Reg)

Line regulation is the ability of the regulator to maintain a constant output voltage as the input voltage changes. The line regulation is specified as the input voltage is changed from $V_{IN} = V_{OUT} + 1\text{ V}$ to $V_{IN} = V_{OUT} + 6\text{ V}$. It is a pulsed measurement to minimize temperature effects.

LOAD REGULATION (Load Reg)

Load regulation is the ability of the regulator to maintain a constant output voltage as the load current changes. It is a pulsed measurement to minimize temperature effects with the input voltage set to $V_{IN} = V_{OUT} + 1\text{ V}$. The load regulation is specified under two output current step conditions of 5 mA to 100 mA and 5 mA to 200 mA.

QUIESCENT CURRENT (I_Q)

The quiescent current is the current which flows through the ground terminal under no load conditions ($I_{OUT} = 0\text{ mA}$).

GROUND PIN CURRENT (I_{GND})

The ground pin current is the current which flows through the GND terminal according to load current. It is measured by (input current-output current).

RIPPLE REJECTION RATIO (RR)

Ripple rejection is the ability of the regulator to attenuate the ripple content of the input voltage at the output. It is specified with 200 mV_{RMS}, 400 Hz and 1 kHz signal superimposed on the input voltage, where $V_{IN} = V_{OUT} + 1.5\text{ V}$. The output decoupling capacitor is set to 1.0 μF , the noise bypass capacitor is set to 0.01 μF , and the load current is set to 10 mA. Ripple rejection is the ratio of the ripple content of the output vs. the input and is expressed in dB. Ripple rejection can be improved by increasing the noise bypass capacitor (however, the on/off response time will increase).

STANDBY CURRENT (I_{STBY})

Standby current is the current into the regulator when the output is turned off by the control function. It is measured with an input voltage of 8 V.

OVER CURRENT SENSOR

The over current sensor protects the device when there is excessive output current. It also protects the device if the output is accidentally shorted to ground.

THERMAL SENSOR

The thermal sensor protects the device if the junction temperature exceeds the safe value ($T_j = 150\text{ }^\circ\text{C}$). This temperature rise can be caused by extreme heat, excessive power dissipation caused by large output voltage drops, or excessive output current. The regulator will shut off when the temperature exceeds the safe value. As the junction temperature decreases, the regulator will begin to operate again. Under sustained fault conditions, the regulator output will oscillate as the device turns off then resets. Damage may occur to the device under extreme fault conditions.

REVERSE VOLTAGE PROTECTION

Reverse voltage protection prevents damage due to the output voltage being higher than the input voltage. This fault condition can occur when the output capacitor remains charged and the input is reduced to zero, or when an external voltage higher than the input voltage is applied to the output side. Toko's regulators do not need an inherent diode connected between the input and output. The maximum reverse bias voltage is 6 V.

DEFINITION AND EXPLANATION OF TECHNICAL TERMS (CONT.)

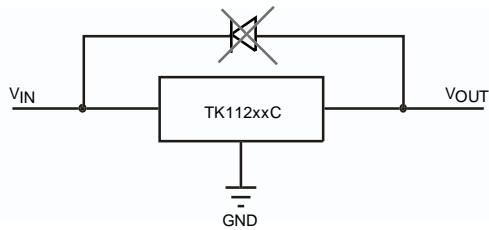

PACKAGE POWER DISSIPATION (P_D)

This is the power dissipation level at which the thermal sensor is activated. The IC contains an internal thermal sensor which monitors the junction temperature. When the junction temperature exceeds the monitor threshold of 150 °C, the IC is shut down. The junction temperature rises as the difference between the input power ($V_{IN} \times I_{IN}$) and the output power ($V_{OUT} \times I_{OUT}$) increases. The rate of temperature rise is greatly affected by the mounting pad configuration on the PCB, the board material, and the ambient temperature. When the IC mounting has good thermal conductivity, the junction temperature will be low even if the power dissipation is large. When mounted on the recommended mounting pad, the power dissipation of the SOT23L-6 is increased to 600 mW. For operation at ambient temperatures over 25 °C, the power dissipation of the SOT23L-6 device should be derated at 4.8 mW/°C. To determine the power dissipation for shutdown when mounted, attach the device on the actual PCB and deliberately increase the output current (or raise the input voltage) until the thermal protection circuit is activated. Calculate the power dissipation of the device by subtracting the output power from the input power. These measurements should allow for the ambient temperature of the PCB. The value obtained from $P_D / (150\text{ °C} - T_A)$ is the derating factor. The PCB mounting pad should provide maximum thermal conductivity in order to maintain low device temperatures. As a general rule, the lower the temperature, the better the reliability of the device. The thermal resistance when mounted is expressed as follows:

$$T_j = \theta_{jA} \times P_D + T_A$$

For Toko ICs, the internal limit for junction temperature is 150 °C. If the ambient temperature (T_A) is 25 °C, then:

$$\begin{aligned} 150\text{ °C} &= \theta_{jA} \times P_D + 25\text{ °C} \\ \theta_{jA} &= 125\text{ °C} / P_D \\ \theta_{jA} &= 125\text{ °C} / P_D\text{ (°C / mW)} \end{aligned}$$

P_D is the value when the thermal protection circuit is activated. A simple way to determine P_D is to calculate $V_{IN} \times I_{IN}$ when the output side is shorted. Input current gradually falls as temperature rises. You should use the value when thermal equilibrium is reached.

The range of usable currents can also be found from the graph below.

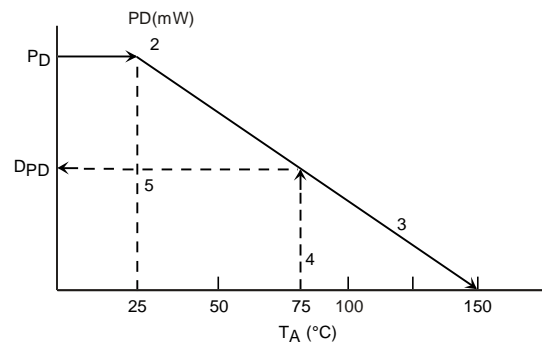

Procedure:

- 1) Find P_D
- 2) P_{D1} is taken to be $P_D \times (-0.8 - 0.9)$
- 3) Plot P_{D1} against 25 °C
- 4) Connect P_{D1} to the point corresponding to the 150 °C with a straight line.
- 5) In design, take a vertical line from the maximum operating temperature (e.g., 75 °C) to the derating curve.
- 6) Read off the value of P_D against the point at which the vertical line intersects the derating curve. This is taken as the maximum power dissipation, D_{PD} .

The maximum operating current is:

$$I_{OUT} = (D_{PD} / (V_{IN(MAX)} - V_{OUT}))$$

APPLICATION INFORMATION (CONT.)

BOARDLAYOUT

SOT23L-6 BOARDLAYOUT

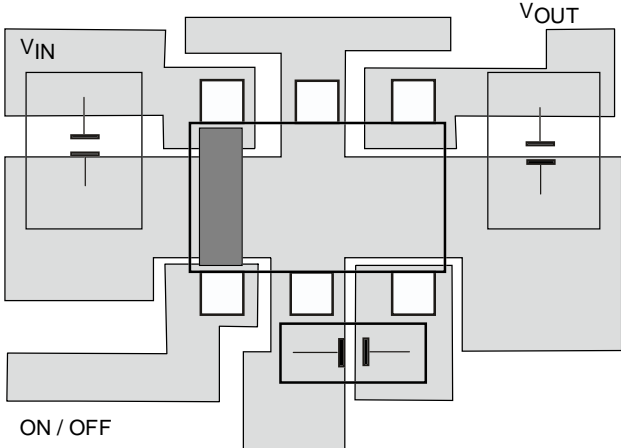

Power dissipation is 600 mW when mounted as recommended. Decrease at the rate of 4.8 mW/°C for operation above 25 °C.

DERATING CURVE

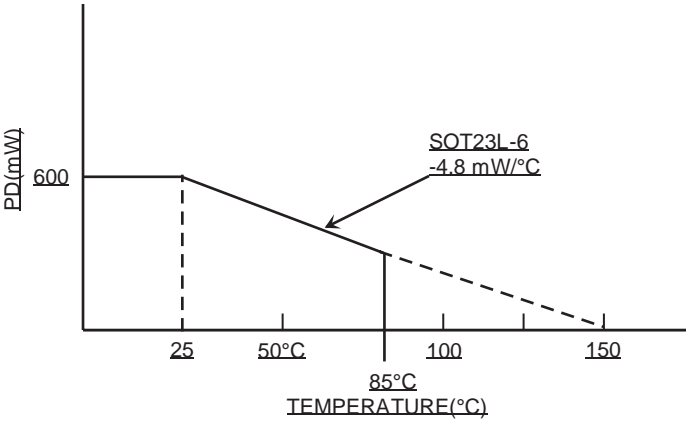

APPLICATION INFORMATION

Application Hint

On / Off Control

It is recommended to turn the regulator Off when the circuit following the regulator is not operating. A design with little electric power loss can be implemented. We recommend the use of the on / off control of the regulator without using a high side switch to provide an output from the regulator. A highly accurate output voltage with low voltage drop is obtained.

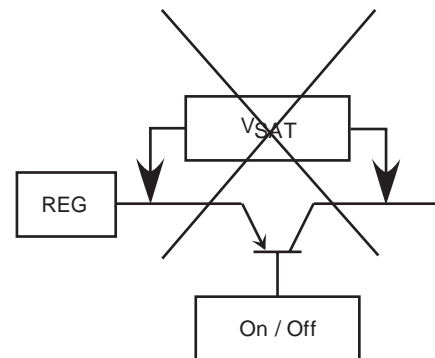

Because the control current is small, it is possible to control it directly by CMOS logic. The PULLDOWN resistance is built into the control terminal (500 k Ω). The noise and ripple rejection characteristics depend on the capacitance on the NOISE BYPASS terminal. The ripple rejection characteristic of the low frequency region improves by increasing the capacitance of C_N . A standard value is $C_N = 0.068 \mu\text{F}$. Increase C_N in a design with important output noise and ripple rejection requirements. The IC will not be damaged if the capacitor value is increased. The switching speed of off / on changes depending on the capacitance at the Noise Bypass terminal. The switching speed slows when the capacitance is large.

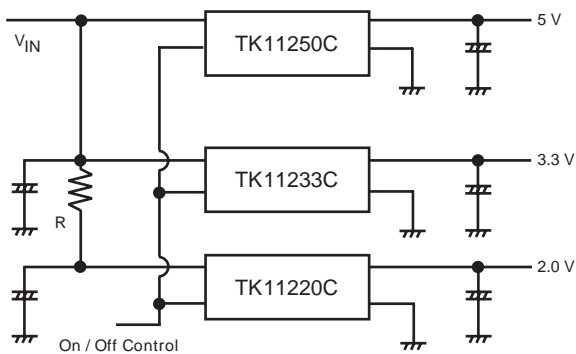

There is an overheating concern because the power loss of the low voltage output (TK11220) IC is large. If necessary, decrease the electric power loss by using the resistor (R) as shown in the left chart. When the thermal sensor works, a decrease of the output voltage, oscillation, etc. are observed.

APPLICATION INFORMATION

INPUT-OUTPUT CAPACITORS

Linear regulators require input and output capacitors in order to maintain the regulator's loop stability. The equivalent series resistance (ESR) of the output capacitor must be in the stable operation area. However, it is recommended to use as large a value of capacitance as is practical. The output noise and the ripple noise decrease as the capacitance value increases. The IC is never damaged by enlarging the capacitance.

ESR values vary widely between ceramic and tantalum capacitors. However, tantalum capacitors are assumed to provide more ESR damping resistance, which provides greater circuit stability. This implies that a higher level of circuit stability can be obtained by using tantalum capacitors when compared to ceramic capacitors with similar values. The IC provides stable operation with an output side capacitor of $0.22\mu\text{F}$ ($V_{\text{OUT}} \geq 2.0\text{ V}$). If the capacitor is $0.1\mu\text{F}$ or more over its full range of temperature, either a ceramic capacitor or tantalum capacitor can be used without considering ESR ($V_{\text{OUT}} \geq 2.0\text{ V}$).

For output voltage device $\geq 2.0\text{ V}$ applications, the recommended value of $C_L \geq 0.22\mu\text{F}$.

For output voltage device $\geq 1.5\text{ V}$ applications, the recommended value of $C_L \geq 0.47\mu\text{F}$.

For load current $\leq 0.5\text{ mA}$, increase the output capacitor to $1\mu\text{F}$.

The input capacitor is necessary when the battery is discharged, the power supply impedance increases, or the line distance to the power supply is long. This capacitor might be necessary on each individual IC even if two or more regulator ICs are used. It is not possible to determine this indiscriminately. Please confirm the stability while mounted.

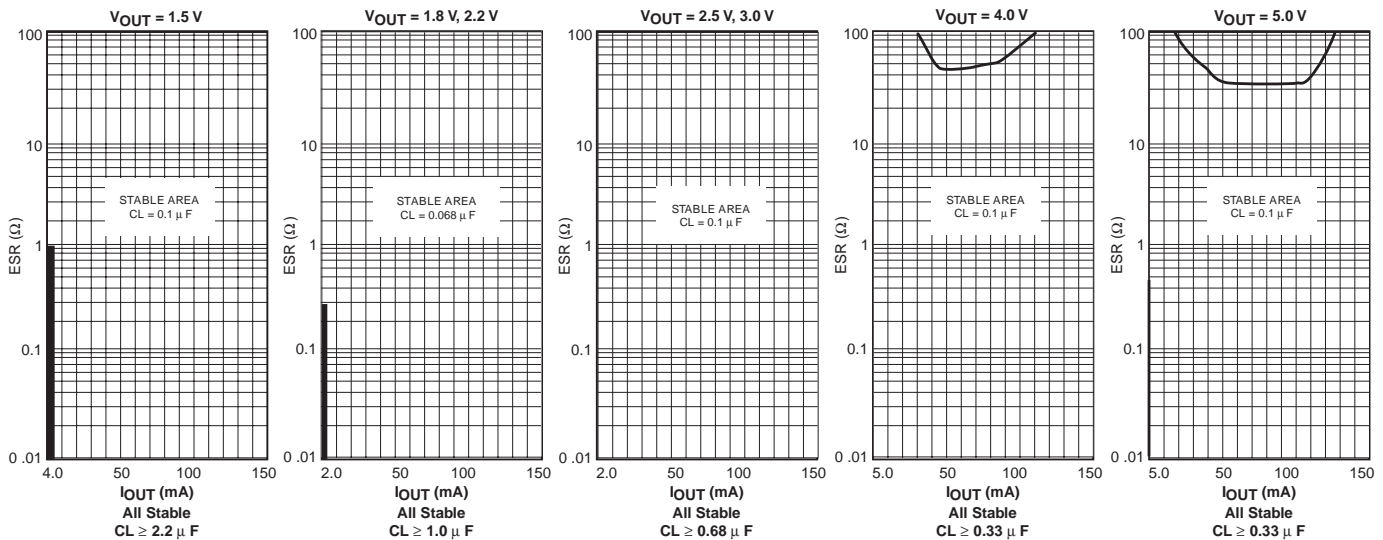
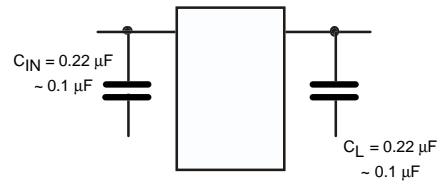

Please increase the output capacitor value when the load current is 0.5 mA or less. The stability of the regulator improves if a big output side capacitor is used (the stable operation area extends).

For evaluation Kyocera: CM05B104K10AB, CM05B224K10AB, CM105B104K161, CM105B224K16A, CM21B225K10A
 Murata: GRM36B104K10, G4M42B104K10, GRM39B014K25, GRM39B224K10, GRM39B105K6.3

APPLICATION INFORMATION (CONT)

Generally, a ceramic capacitor has both a temperature characteristic and voltage characteristic. Please consider both characteristics when selecting the part. The B curves are the recommended characteristics.

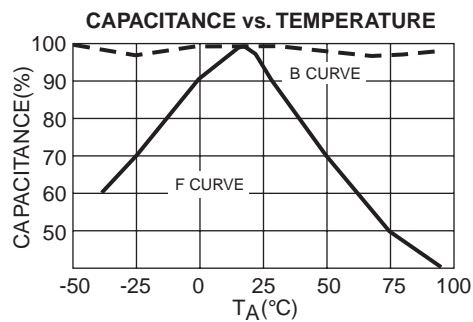
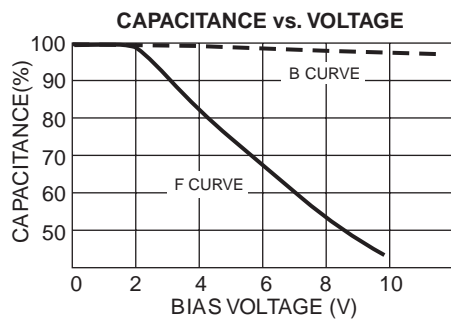

PACKAGE OUTLINE

SOT23L-6

Dimensions are shown in millimeters
Tolerance: x.x = ± 0.2 mm (unless otherwise specified)

Note: Pin 2 and Pin 5 should be grounded for heat dissipation

Marking Information

Product Code	R	Voltage Code
TK11215C	15	
TK11216C	16	
TK11217C	17	
TK11218C	18	
TK11219C	19	
TK11220C	20	
TK11221C	21	
TK11222C	22	
TK11223C	23	
TK11224C	24	
TK11225C	25	
TK11226C	26	
TK11227C	27	
TK11228C	28	
TK11229C	29	
TK11230C	30	
TK11231C	31	
TK11232C	32	
TK11233C	33	
TK11234C	34	
TK11235C	35	
TK11236C	36	
TK11237C	37	
TK11238C	38	
TK11239C	39	
TK11240C	40	
TK11241C	41	
TK11242C	42	
TK11243C	43	
TK11244C	44	
TK11245C	45	
TK11246C	46	
TK11247C	47	
TK11248C	48	
TK11249C	49	
TK11250C	50	



Toko America, Inc. Headquarters
 1250 Feehanville Drive, Mount Prospect, Illinois 60056
 Tel: (847) 297-0070 Fax: (847) 699-7864

TOKO AMERICA REGIONAL OFFICES

Midwest Regional Office
 Toko America, Inc.
 1250 Feehanville Drive
 Mount Prospect, IL 60056
 Tel: (847) 297-0070
 Fax: (847) 699-7864

Semiconductor Technical Support
 Toko Design Center
 4755 Forge Road
 Colorado Springs, CO 80907
 Tel: (719) 528-2200
 Fax: (719) 528-2375

Visit our Internet site at <http://www.tokoam.com>

The information furnished by TOKO, Inc. is believed to be accurate and reliable. However, TOKO reserves the right to make changes or improvements in the design, specification or manufacture of its products without further notice. TOKO does not assume any liability arising from the application or use of any product or circuit described herein, nor for any infringements of patents or other rights of third parties which may result from the use of its products. No license is granted by implication or otherwise under any patent or patent rights of TOKO, Inc. TOKO's products are not authorized for use as critical components in life support devices or systems without the express written approval of the president of Toko, Incorporated.